

Article number: 12733000040120

Description: KLEE-coil 733 000 040.120
M4 Steel, zinc-pl. & chr. yellow

Measures

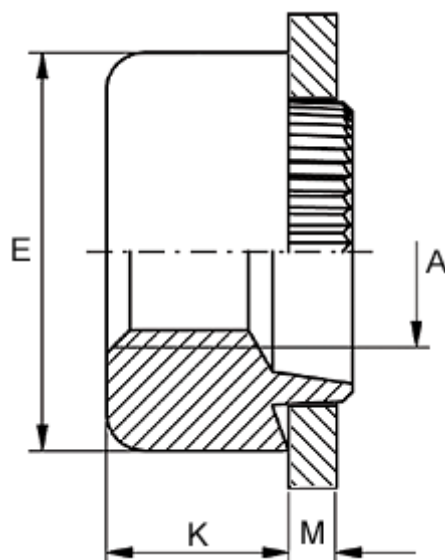

Female thread A	= M4
Height K	= 3.0
Outer diameter E	= 7.0
Plate thickness	= 3.5 to 3.7
Recommended bore diameter +0.05	= 6.0